

IoTForum 2019

#RaiseIoTQuotient

Arvind Tiwary
Chair IoTForum





Knowledge Partners



Gold Partner



Supported By



IoTNext Award Sponsor



Key Sponsor



Associate Sponsor



Country Partner



Media Partner



Partners



2019 IoT Start-up Directory

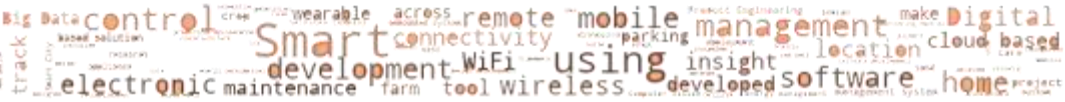
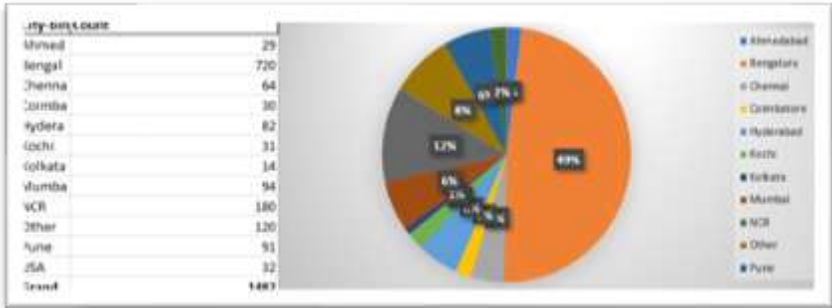
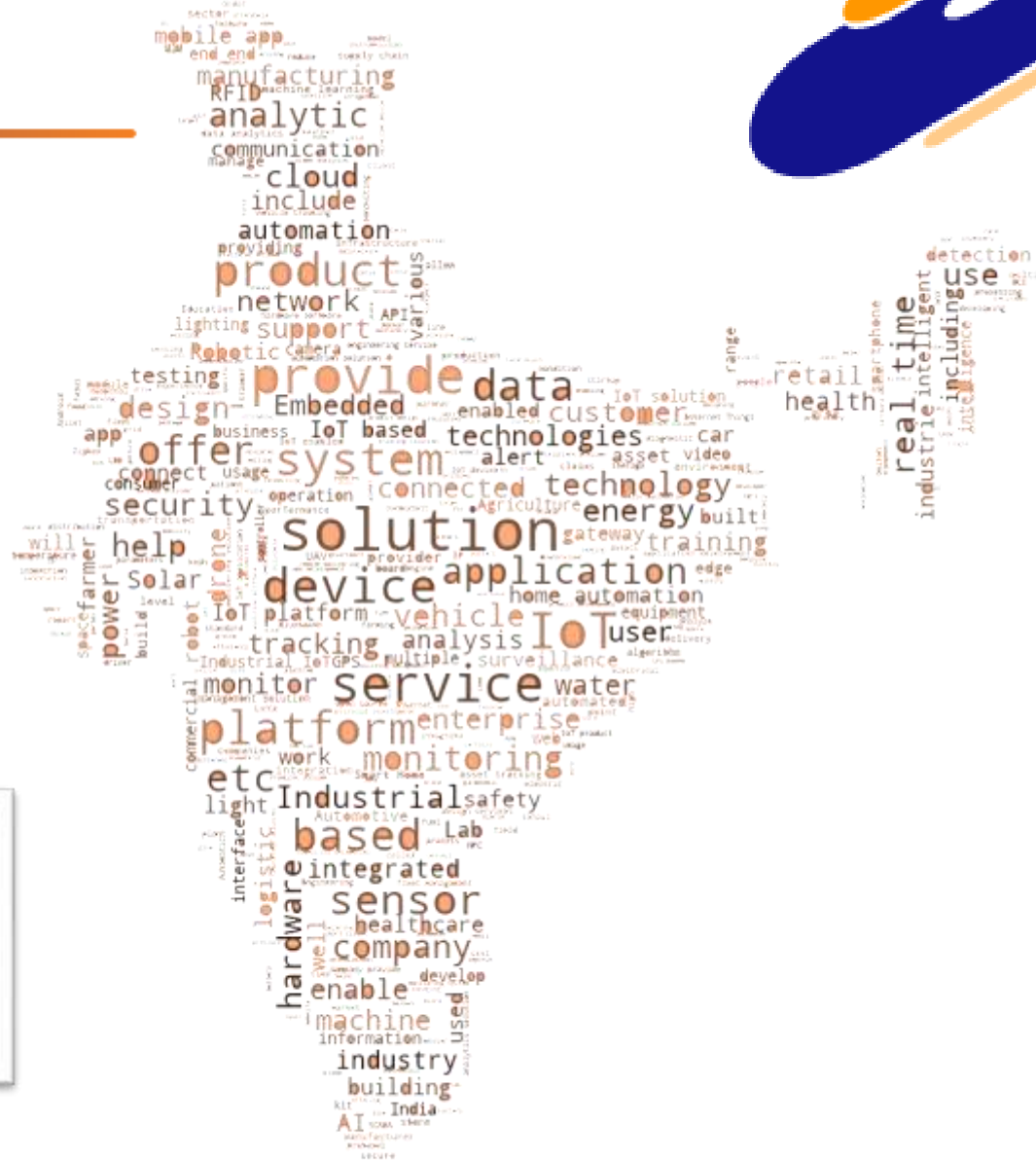

Events

IoTforIndia2

That's not all!
Witness other experts talk live

Prasanna Kishanmurthy
Co-founder, UpSkillify

Kishan Wadhwa
Co-founder & CEO, Whopix

Nagsamudra Daswamy
Founder and Managing Director at IdeaSpring

And More...

[Register Now](#)

Date: 27th November 2019
Venue: The Leela Palace, Bengaluru

TiE Mentorship Drive | Accel Partners B2B SaaS
- What it takes to scale? | SAP Startup Social |

50+ general TiE
10+ IoT
Monthly Meet

All Day

AgriTech
IoTDay

IIoT Summi

IoTNext

TE BRIDGE

27 June, 2019 11 am - 2 pm
Cisco, Kadubesanahalli

IoTForum Monthly Meet - Aug 2019: A workshop on Azure IoT and ST MCUs

Join us for a unique hands-on full-day technical workshop on AI and Edge analytics organized by TiE IoTForum in partnership with Microsoft and ST Microelectronics.

02 December 2019

IoTNext 2019

Get access to the best of AR/VR/AI and IoT Startups at Xperience Zone

[Find out more »](#)

18 October 2019

The Things Conference India 2019

Asia's largest conference on LoRaWAN aims to build a bigger, better and stronger IoT and LoRaWAN ecosystem for a Smart India.

[Find out more »](#)

10 August 2019

IoTForum Monthly Meet -Aug 2019: A workshop on Azure IoT and ST MCUs

Join us for a unique hands-on full-day technical workshop on AI and Edge analytics organized by TiE IoTForum in partnership with Microsoft and ST Microelectronics.

[Find out more »](#)

02 August 2019

IEEE SmartTech 2019

IEEE Bangalore Section is organizing the 6th edition of IEEE SmartTech on 2-3 August 2019, with a focus on the



IoT FOR INDIA

IoT Forum is a TIE Bangalore initiative to foster entrepreneurship and mentor start-ups in the emerging IoT arena. Started in June 2014, IoT Forum has hosted 36+ events and touched 3,300+ participants and 420+ startups.

PARTNERS



EVENTS FOR PRACTITIONERS

- › Contiki Workshop on Middleware for IoT
- › Bluetooth Technical Deep Dive Session
- › MEMS Technical Deep Dive Session



BUSINESS CONNECTS

- › Leveraging Use cases to Validate IoT Opportunities
- › Smart Vehicles - The IoT Future
- › Smart Agriculture and Smart Healthcare



Current IoTForum Members



 Thinklayer

VILLAGE
ENERGY

 EmbedSense
IDEAS THAT PERFORM

FUTUREIP™
The Future is Now

Syook

 embitel
delivered with passion

 SenseGiz
Set no limits...

 smarter
homes™

tii third-i
inventech

 Sensorise



ZestIoT
TECHNOLOGIES PRIVATE LIMITED

TISMO
Embedding Excellence

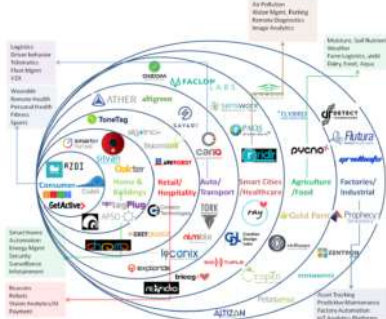

technosphere

ZUPPA

IoT Startup Directory



Welcome



Raising the IoT Quotient of India with IoTForum an initiative of TIE Bangalore and IESA

IoTForum Channel

Get 4-10 news items delivered to you anywhere everyday!

Subscribe to IoTForIndia Mobile

Register

Join as a user at IoTForIndia and Raise the IoT Quotient of India.

[Click Here TO REGISTER](#)

EnduringInsight HelicopterView ThoughtProvoking

Posted on July 3, 2017 by Manish
The Startup Funding in India for IoT Startups

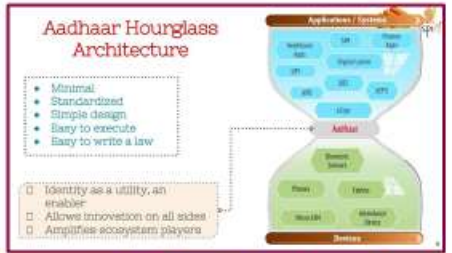

- Minimal
- Standardized
- Simple design
- Easy to execute
- Easy to write a law

- Identify as a utility, an enabler
- Allows innovation on all sides
- Amplifies ecosystem players

Internet of Things (IoT) Startups in India - Jan 2017

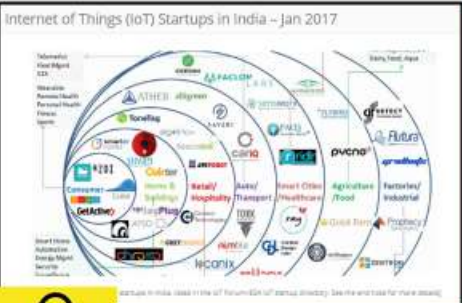

Network	Hub	Gateway	Platform	Application	Standard
Public	Repeater / Router	Smartphone (BLE/GPRS)	Open source	Food trace	SmartRTTS
Enterprise		WiFi Router (Linux)	IBM	City Management	Smart
Consumer		Linux Base station	Nokia	System Admin	Smart
Mobile			Microsoft	City One	Smart
			Nokia	Operation Centre	Smart
				Device Provisioning	Smart
				Dashboard Open	Smart

IOT INTEROPERABILITY USING A SIMPLE ARCHITECTURE

2950+ Topics | 90+ blogs | 40+ Wiki

5,000+ mail subscribers
480+ TG Members
50+ IoTForum Subscribers

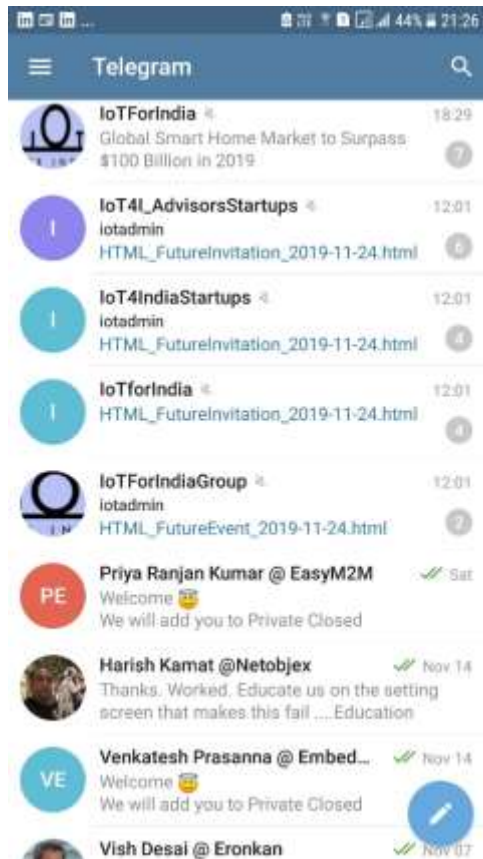

The Monthly newsletter from IoTForum

We summarize curated news, events and blogs from IoTForIndia website and Telegram Groups. This newsletter may be long so we have for The last section offers information on contributions and feedback and helping improve the newsletter and #RaiseIoTQuotient

[Profiles](#) | [Celebrations](#) | [Popular Topics](#) | [Blogs](#) | [Future Events](#) | [Feedback](#)

Popular Topic are ranked on views in [IoTForIndia channel](#). It takes a few days for the view count to stabilize. We aim to send the monthly ne

Profiles include Announcements of a Company, a Product or a Skill of free lancers, Consultants or a Company. This is user generated post a

Popular Profiles from IoTForIndia Channel

[India's first all-electric heavy-duty 60-tonne truck](#)
[3d Usher helps manufacture metal and plastic parts](#)
[Battery management: ADI](#)
[Sulzer Sense IOT - wireless condition monitoring](#)
[first Electrical Vehicle 3.3kW AC Charge-Pile for charging multiple kinds of ele](#)
[InfluxDB realtime time series DB for IoT Data with Niagra4](#)
[Advantages & Limitations of Raspberry Pi Compute Module](#)
[Atomberg Technologies Eyes New Product Launches With \\$10 Mn Series A](#)
[Write a good technical specification for an embedded product](#)
[Cradelwise wins EPDA 2019 / Children Products / Nursery award](#)

Celebrations are best viewed with included images or video . User generated content and not warranted by TIEIoTForum

Popular Celebrations from IoTForIndia Channel

[Avanijal in Agriculture and Industry Survey Magazine](#)
[Rabobank SustainableAg Asia Challenge 2019 commends AgNext](#)
[Farme2ForkIndia co winner Best Start up at Rural Innovators Startup Conclave 201](#)

Popular Posts from TG Groups

Future Event as on 2019-10-06

Title	Date	HashTags
IoT in Action Series SantaClara: Microsoft	2019-10-10	#Announcement(Startup) #Event #Meetup [via IoTGroup] #StartDateTime : 10 October 2019 #City : Santa Clara, USA #Organizer : Microsoft
The Things Conference : UK	2019-10-14	#Announcement(IoTStack) #Event #Confrence #Organizer : TTN UK #City : Reading , UK #StartDateTime : 14 October 2019 #EndDateTime : 15 October 2019
Broadband World Forum 2019	2019-10-15	#Announcement(Startup) #Event #Conference [via IoTGroup] #Organizer : informattech #StartDateTime : 15 oct 2019 #City : Amsterdam, Netherlands
1ST IFSA FREQUENCY & TIME CONFERENCE (IFTC' 2019)	2019-10-16	#Announcement(IoTStack) #Event #Confrence #Organizer : IFSA #City : Barcelona, Spain #StartDateTime : 16 October 2019 #EndDateTime : 18 October 2019
LoRa Alliance India Members Meeting 2019	2019-10-17	#Announcement(IoTStack) #Event #Meetup #Organizer : LoRa Alliance #City : NCR #StartDateTime : 17 October 2019 09:00:00 #EndDateTime : 17 October 2019 18:00:00
International Confrence & Recent trends in IoT & Blockchain	2019-10-19	#Announcement(General) #Event #Conference #Organizer : GIET University #City : Gunupur 765022, India #StartDateTime : 19 Oct 2019 #EndDateTime : 20 Oct 2019
ETSI IoT Week 2019	2019-10-21	#Announcement(General) #Event #Seminar #Organizer : ETSI #City : Sophia Antipolis, France #StartDateTime : 21 October 2019 #EndDateTime : 25 October 2019
9th International Conference on the Internet of Things (IoT)	2019-10-22	#Announcement(General) #Event #Seminar #Organizer : ACM International Conference Proceeding Series #City : Bilbao , Spain #StartDateTime : 22 October 2019 #EndDateTime : 25 October 2019 #DueDateTime : 2 June 2019
IEEE CSCN 2019 CALL FOR PAPERS: TRACK ON IOT, URLLC AND V2X	2019-10-28	#Announcement(IoTStack) #Event #Confrence #Organizer : IEEE #City : Granada, Spain #StartDateTime : 28 Oct 2019 #EndDateTime : 30 Oct 2019 #DueDateTime : 20 June 2019
The IOT Solutions World Congress 2019	2019-10-29	#Announcement(General) #Event #Conference #Organizer : IoT Solutions World Congress / Fira Barcelona / Industrial Internet Consortium #City : BARCELONA , Spain #StartDateTime : 29 October 2019 #EndDateTime : 31 October 2019 #Period : Co

IoTForIndia
208 members

TCQE Startup Showcase at India Mobile Congress 2019
[WPID=36358]
#Announcement(Startup) #Invitation #Pitch [via IoTGroup]

#City : NCR #Organizer : COAI #DueDateTime : 04 Oct 2019
#StartDateTime : 14 Oct 2019

Grab the Opportunity
Work with top telecom companies in India and globally, by connecting with the top minds from the Cellular Operators Association of India (COAI) & Telecom Centres of Excellence(TCOE) groups. The teams are looking at engaging with startups for developing cutting edge solutions across various themes & help with GOTO MARKET SUPPORT in India, South East Asia & Africa

TOP 20 SHORTLISTED STARTUPS GET FREE BOOTH FOR 3 DAYS IN INDIA MOBILE CONGRESS 2019

Read More..

Working Bot 0.699999999 Build 23 Aug 2019



Knowledge Discovery

General

M&A / Funding	Market Research
Governance	Tips, Checklists..
Biz Model	Biz Development
Technology Trends	Use cases

Special

Sensors	Edge & Fog
FPGA/ SoC	Block Chain
Drones	Standards
Robotics	AdTech / NFC/RFID/BLE
SW / IDE /Tools	Interoperability

Profiles

Niral Networks

Avanijal

SimShine Technologies

EVQPoint Solutions Pvt. Ltd.

Aryabhata Robotics Private Limited

SimShine, a computer vision company based in Shenzhen, has raised \$1.5 million in seed funding for SimCam, its line of smart cameras that use edge computing on-device.

<http://www.iiotforindia.com>
e-raises-8-million-for-iiot-startup-that-use-edge-computing

Showcases

Drishti

Drishti's technology allows people to use their own technology at scale. The data cap...

Recent (Last item . Scroll up for 6 months or more...)

Blogs

News

Discussions

Product

Company

Skill

Report

Jobs

Invitations

Project Usiru:

Crowd Sourced Air Pollution Reduction



Factors affecting Air Quality, PM reduction, and how we can deliver outcomes for cities like Delhi, Bengaluru and others with solutions from the modern IoT world

Join the conversation at IoTNext 2019. Register now!

iotnext.org

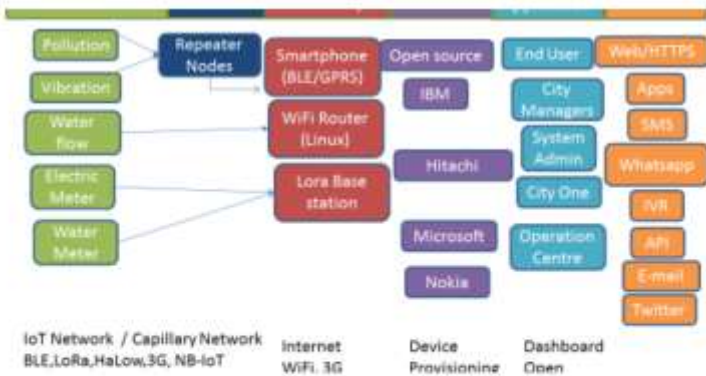

IOT INTEROPERABILITY USING A SIMPLE ARCHITECTURE

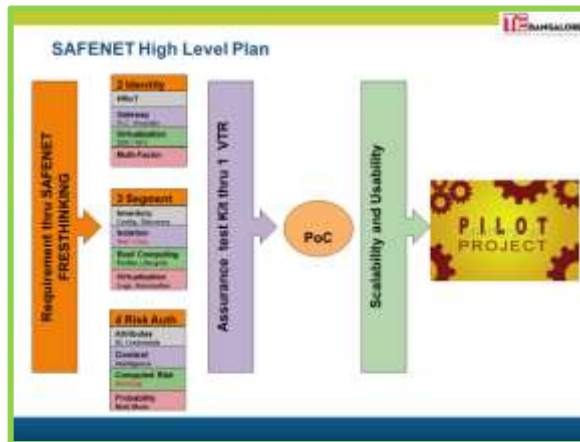

High density Indian urban areas will require **40,000+ IoT devices per sq. km** at 5-10 IoT devices per household. There are scenarios like Dharavi¹ in Mumbai or Mong Kok in Hong Kong with densities exceeding 140,000 /Sq Km

Urban Area	Density / km ²	Approx Households / km ²	5 devices/ household	10 devices/ household
Delhi NCR	12,100	4,033	20,135	40,330
Greater Mumbai	32,400	10,800	54,000	108,000

Sources:
<http://www.arcent.com/blog/2015/02/iot-and-beyond-third-wave-emerges-blending-physical-and-digital>
<http://www.gartner.com/newsroom/id2905717>
 Demographia World Urban Areas 2015 <http://demographia.com/db-worldua.pdf>

Join the Project: Raising the IoT Quotient of India

- Spread the word
- Curate News ,Ask Questions
- Engage in Dialogue and Inquiry
- Contribute and Enrich



iotforumweb@tiebangalore.org



www.iotforindia.org



[@iotforindia](https://twitter.com/iotforindia)



IoTForIndia

<https://t.me/IoTForIndia>